

Garage double 6x6 (44)

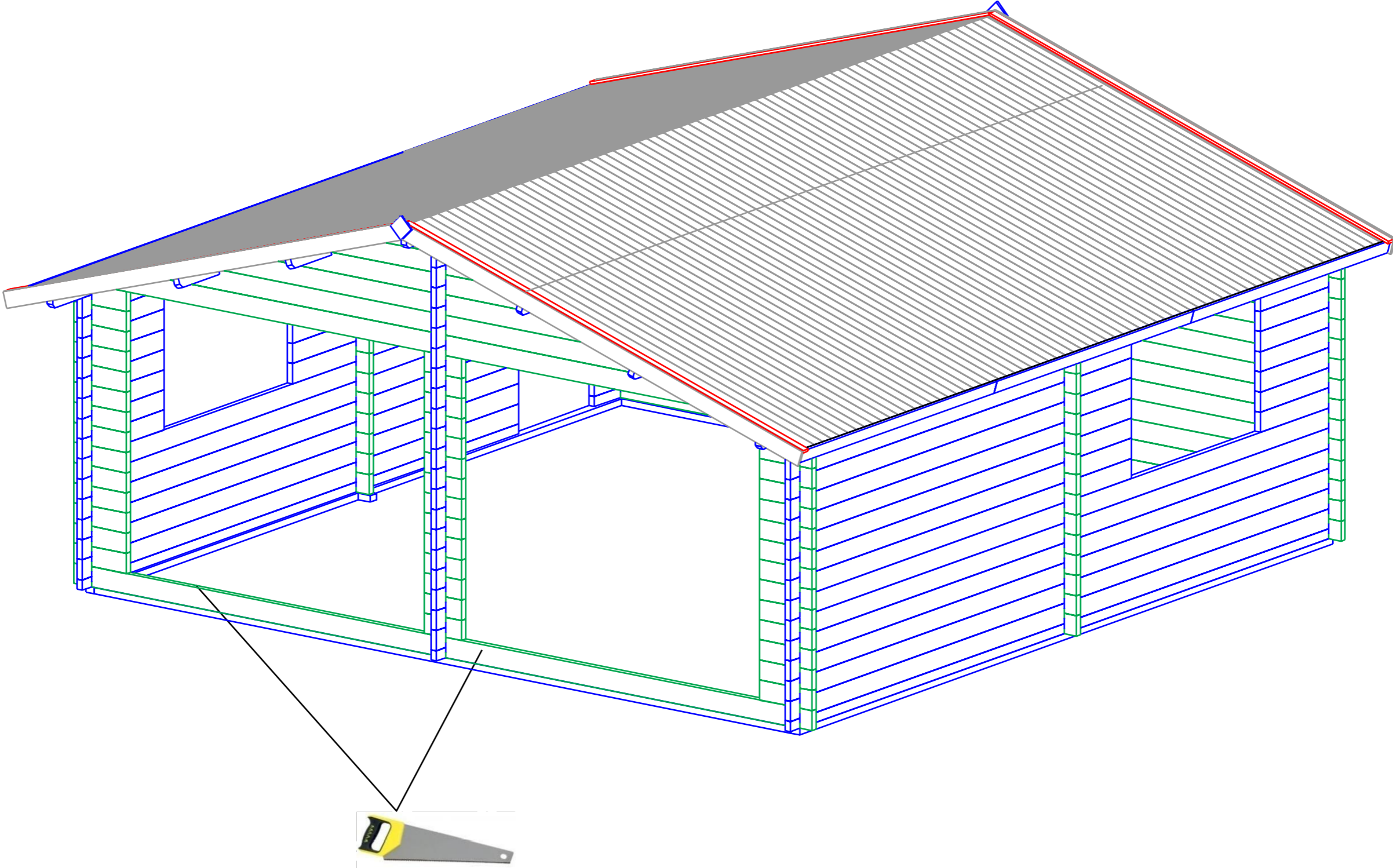

Garage double 6x6 (44)

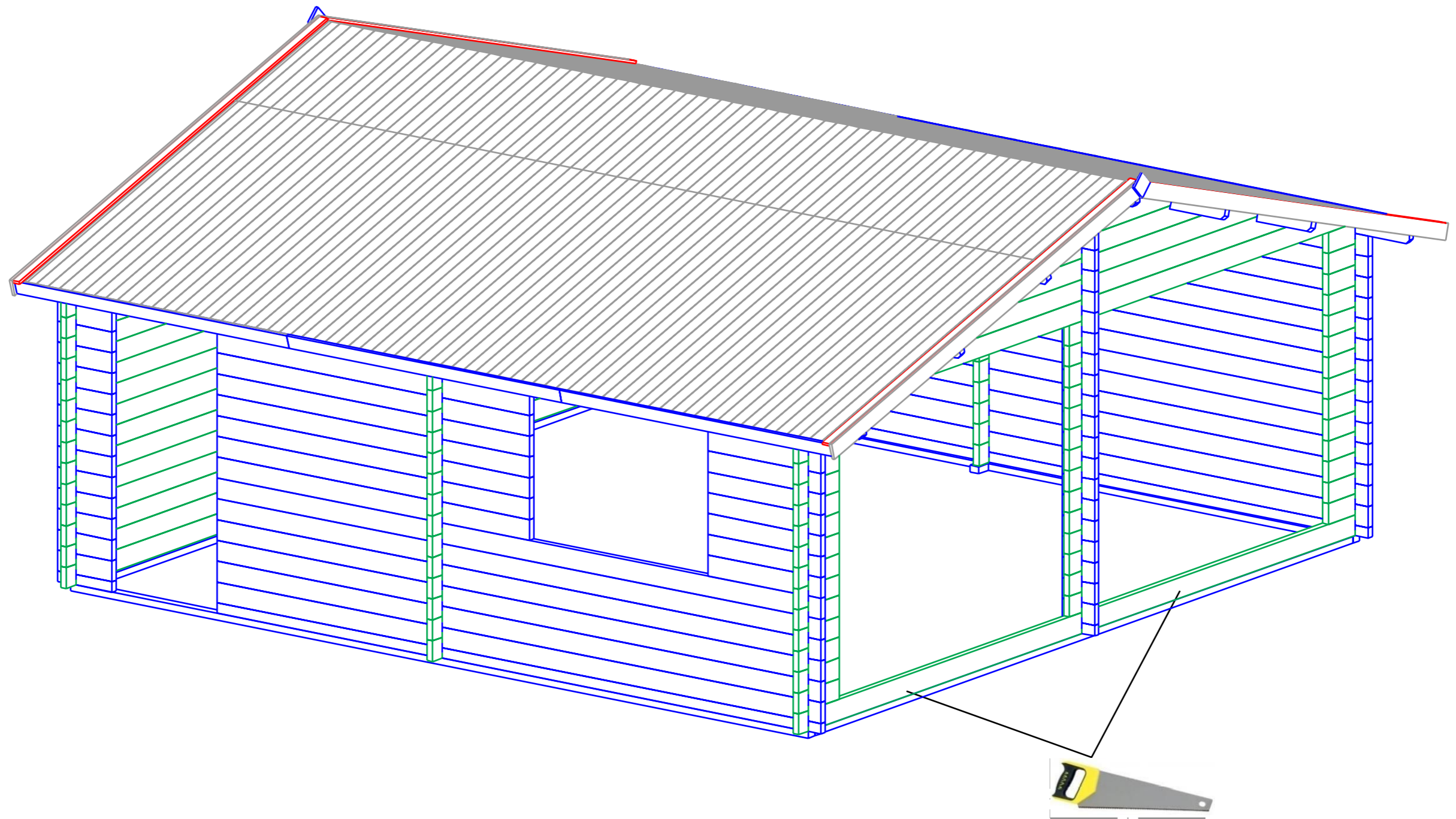

Garage double 6x6 (44)

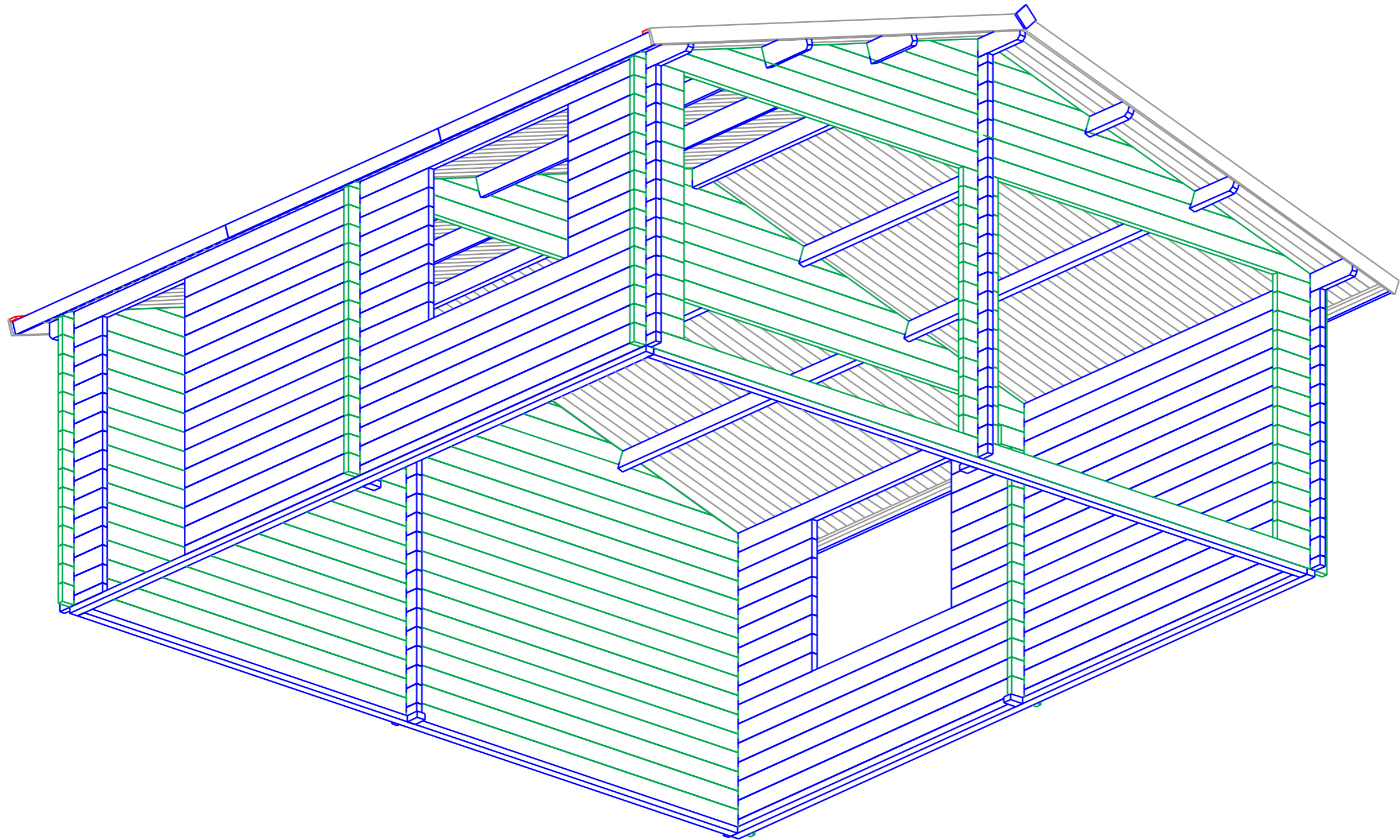

Garage double 6x6 (44)

Plan

M 1:50

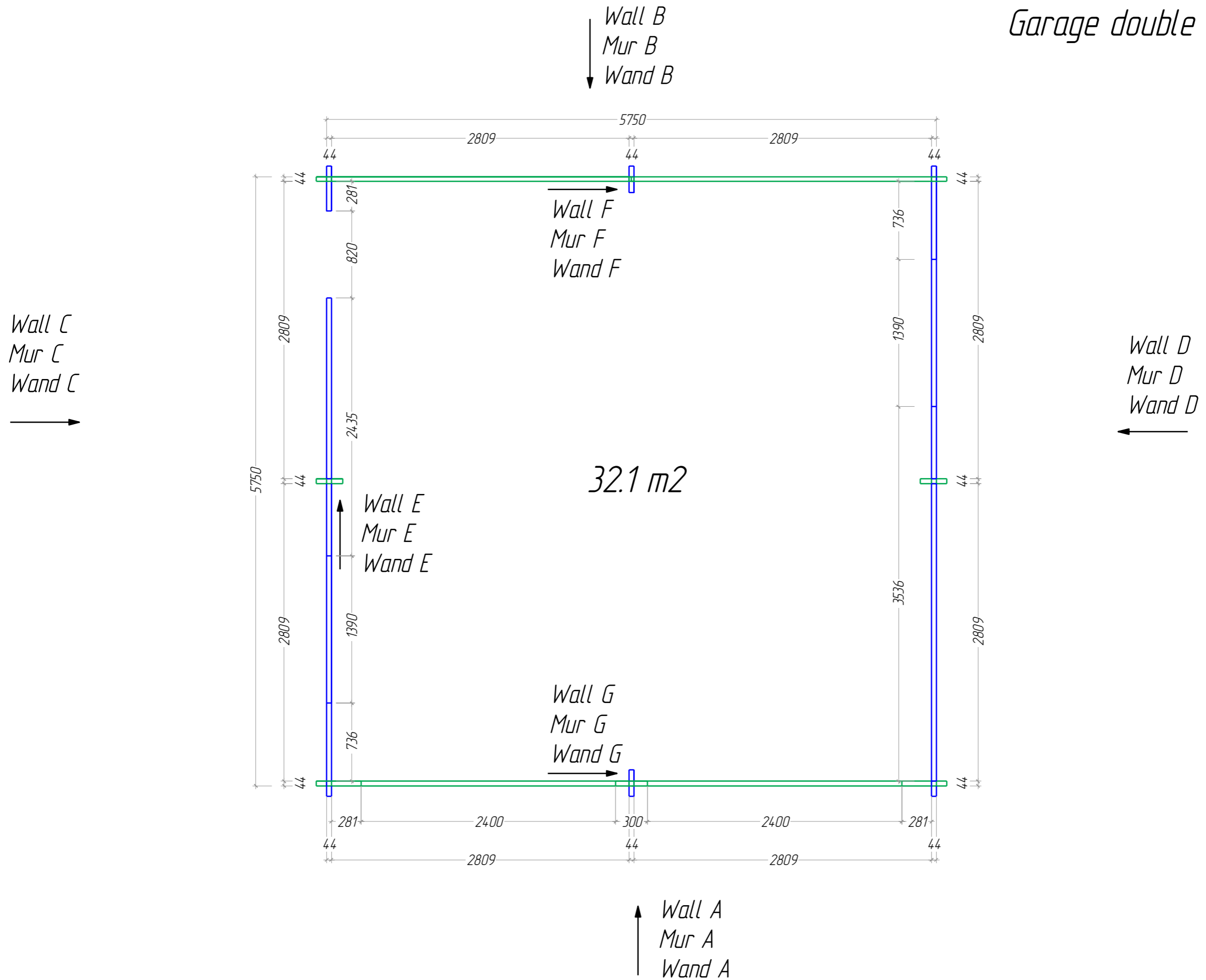

Garage double 6x6 (44)
M 1:40

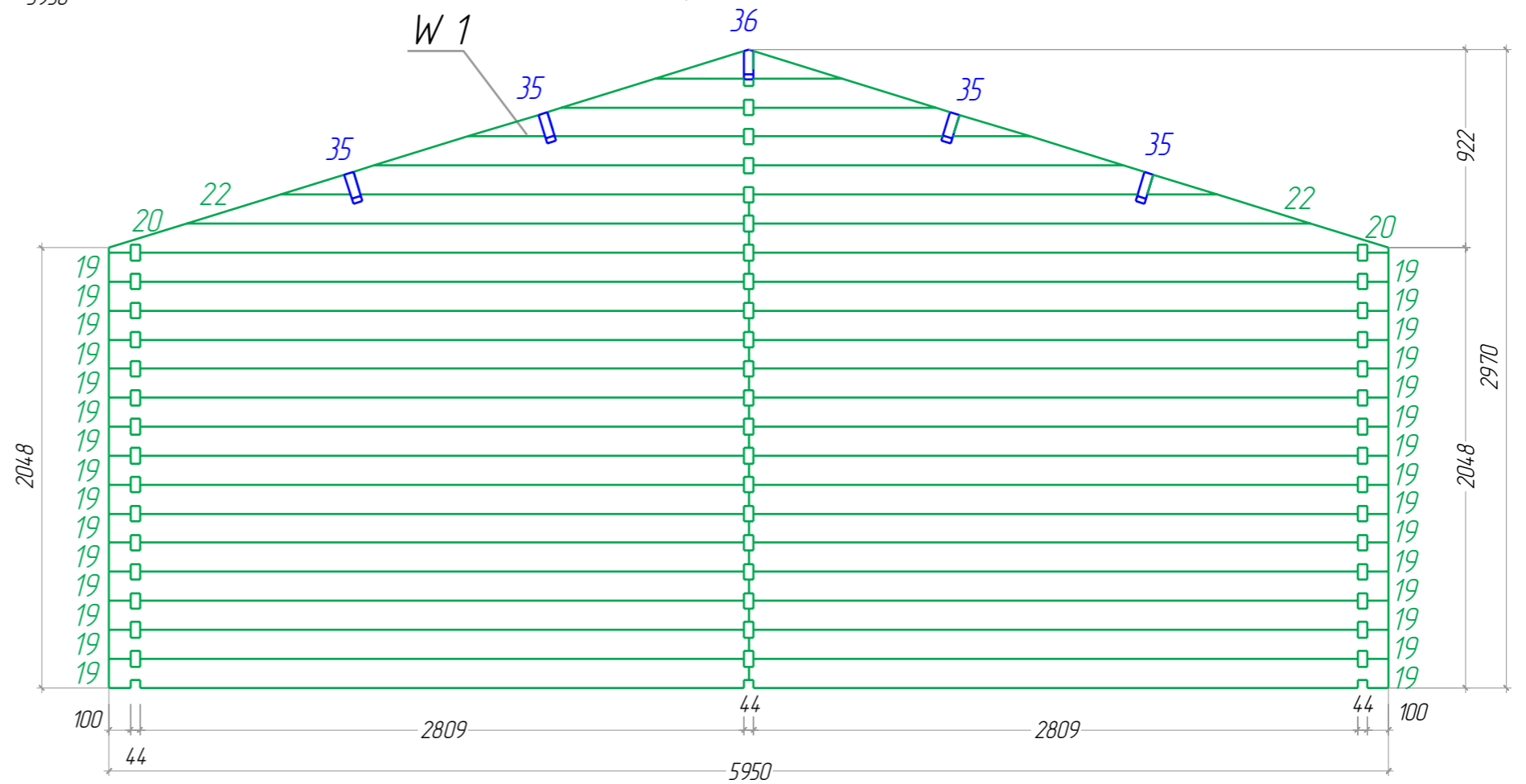
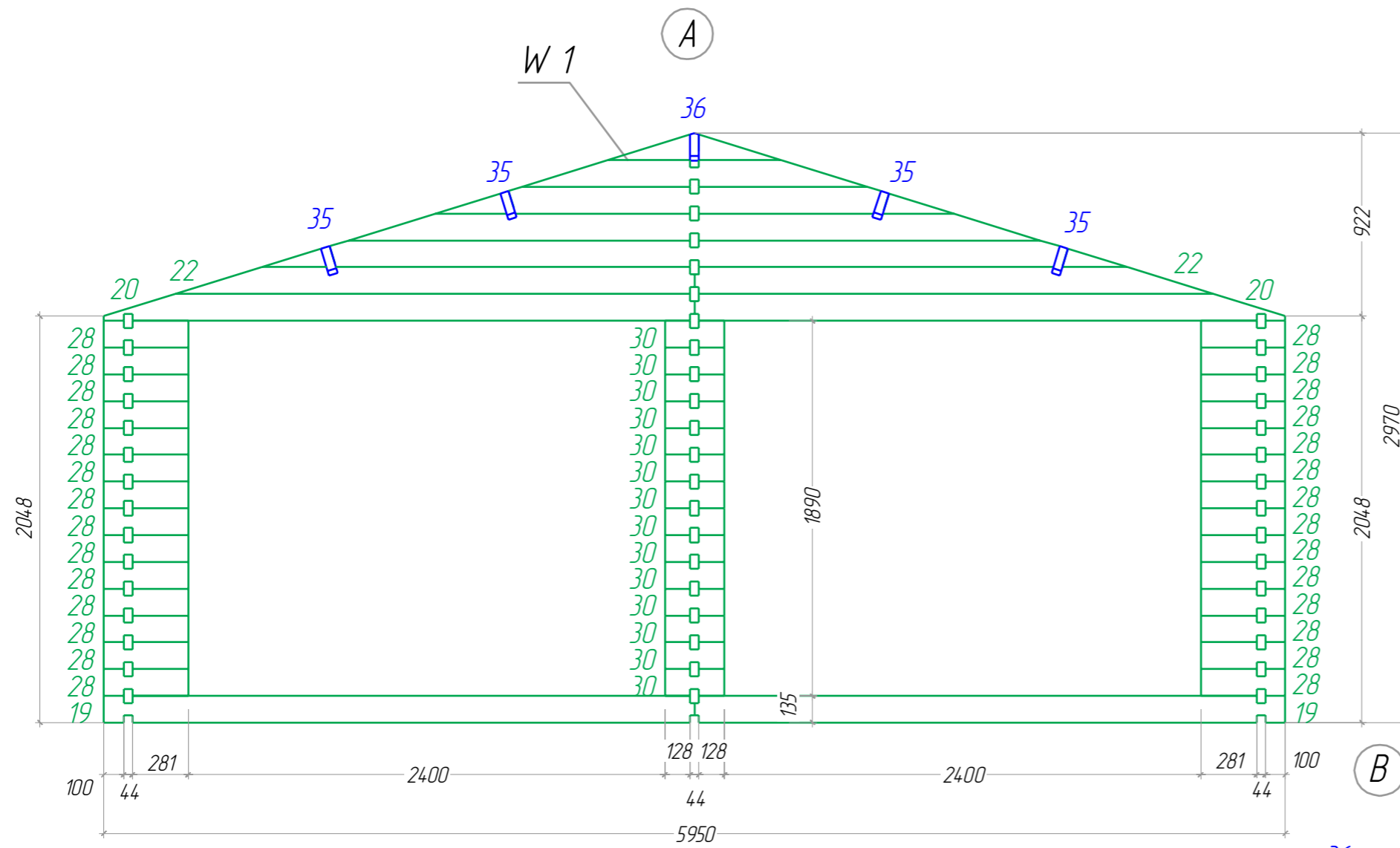

Garage double 6x6 (44)
M 1:40

C

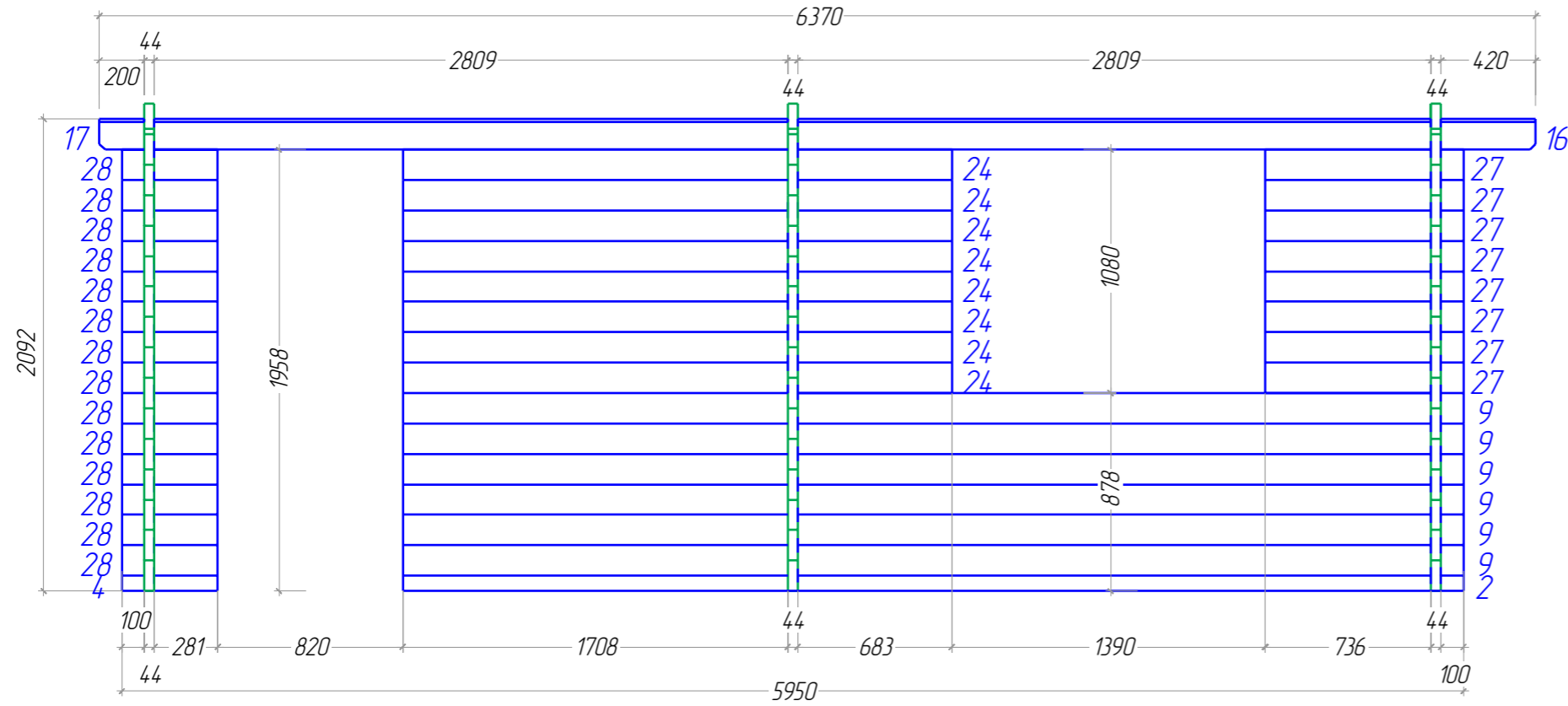

D

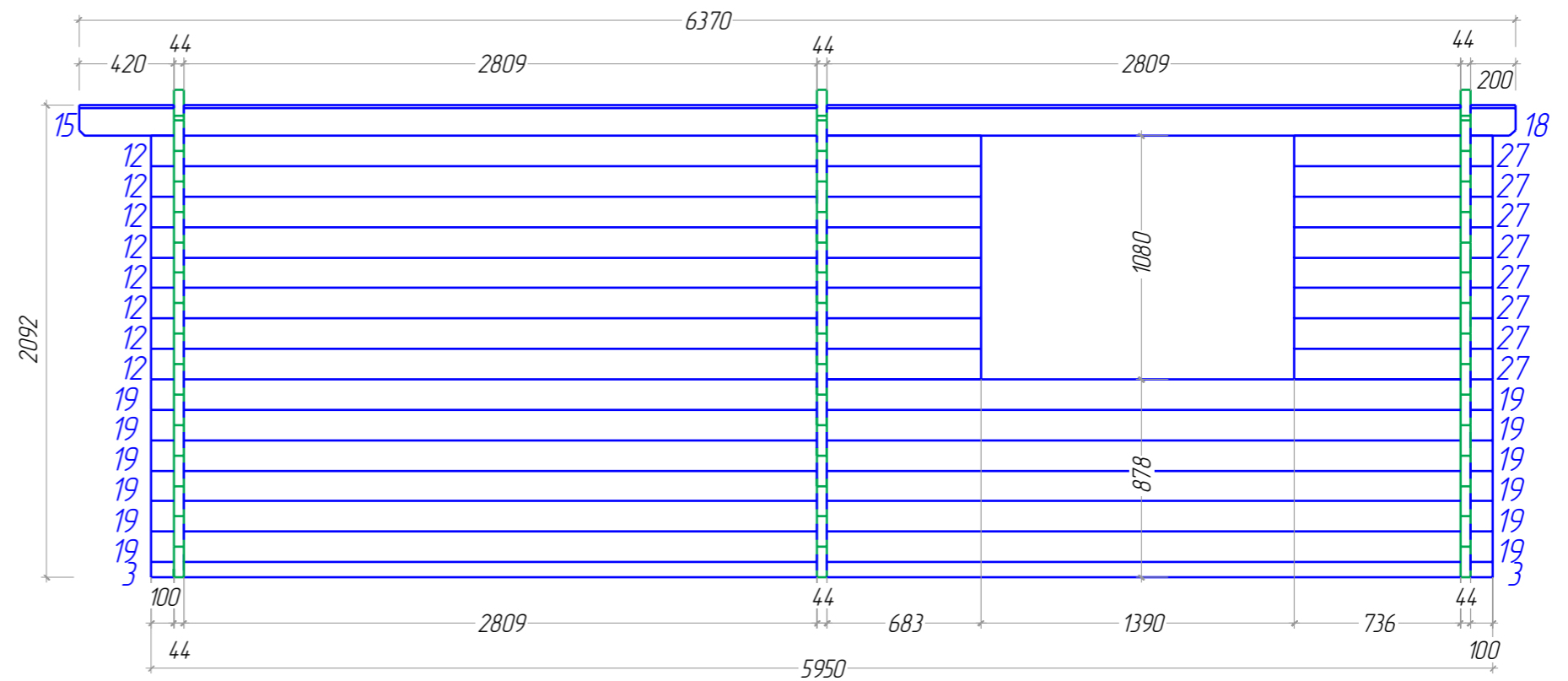

E

Garage double 6x6 (44)
M 1:40

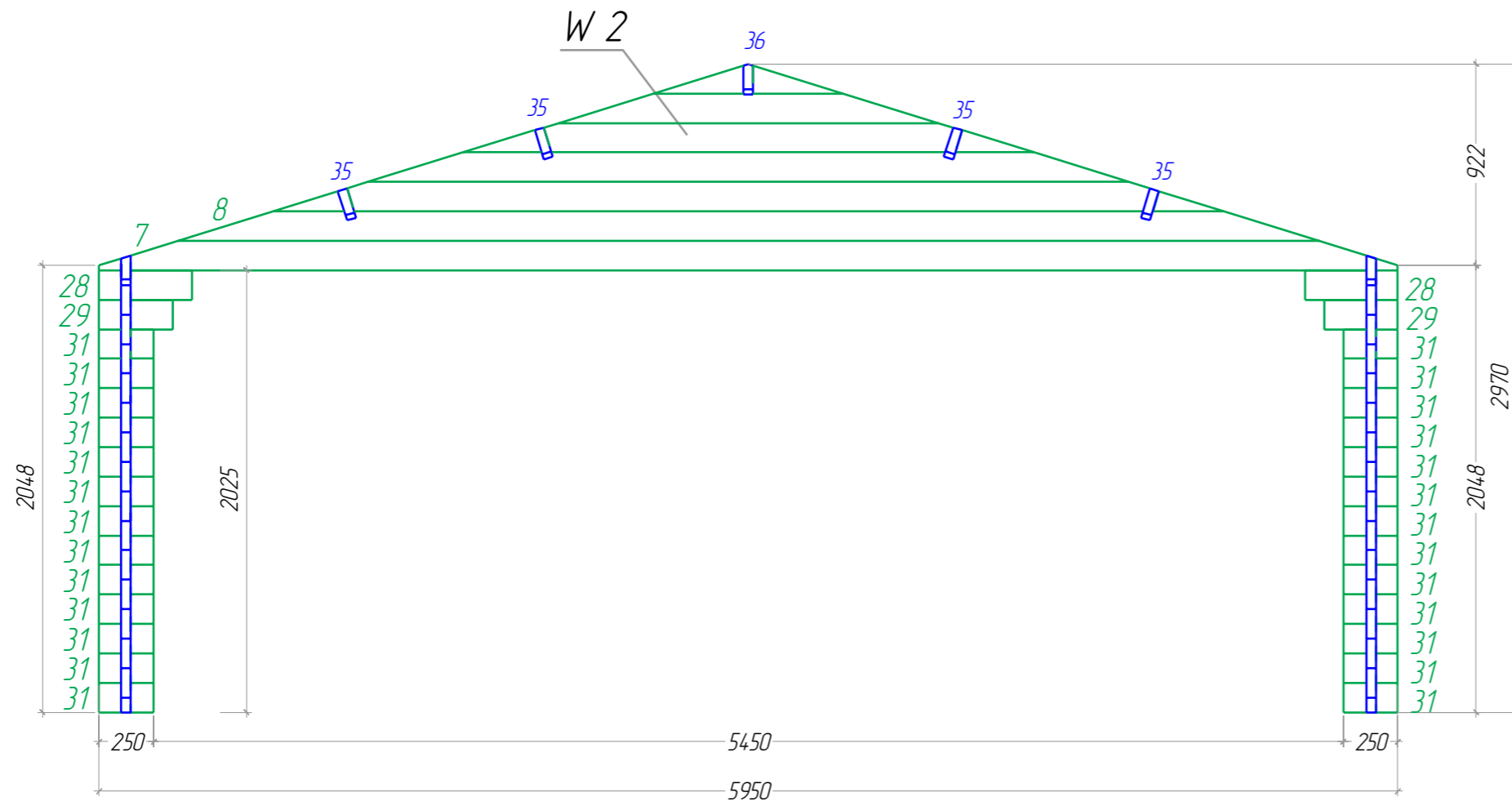

G

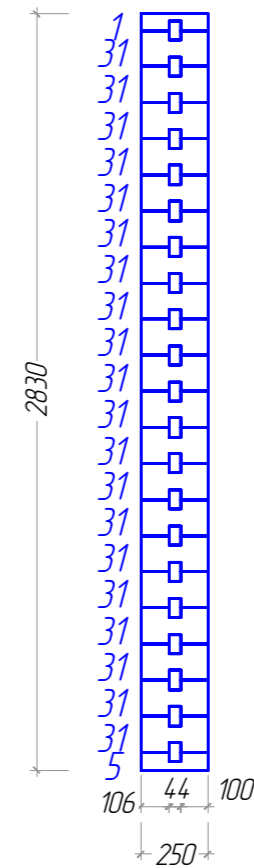

F

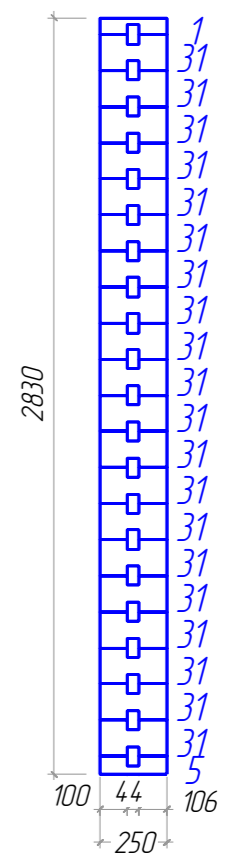

Garage double 6x6 (44)
M 1:40

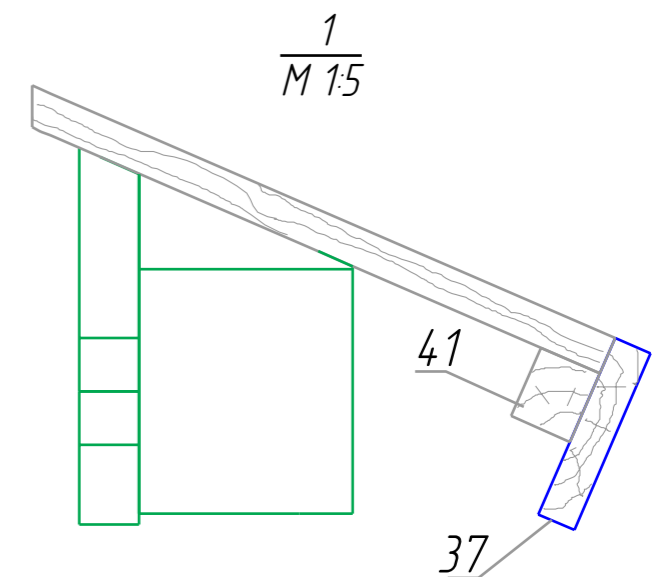
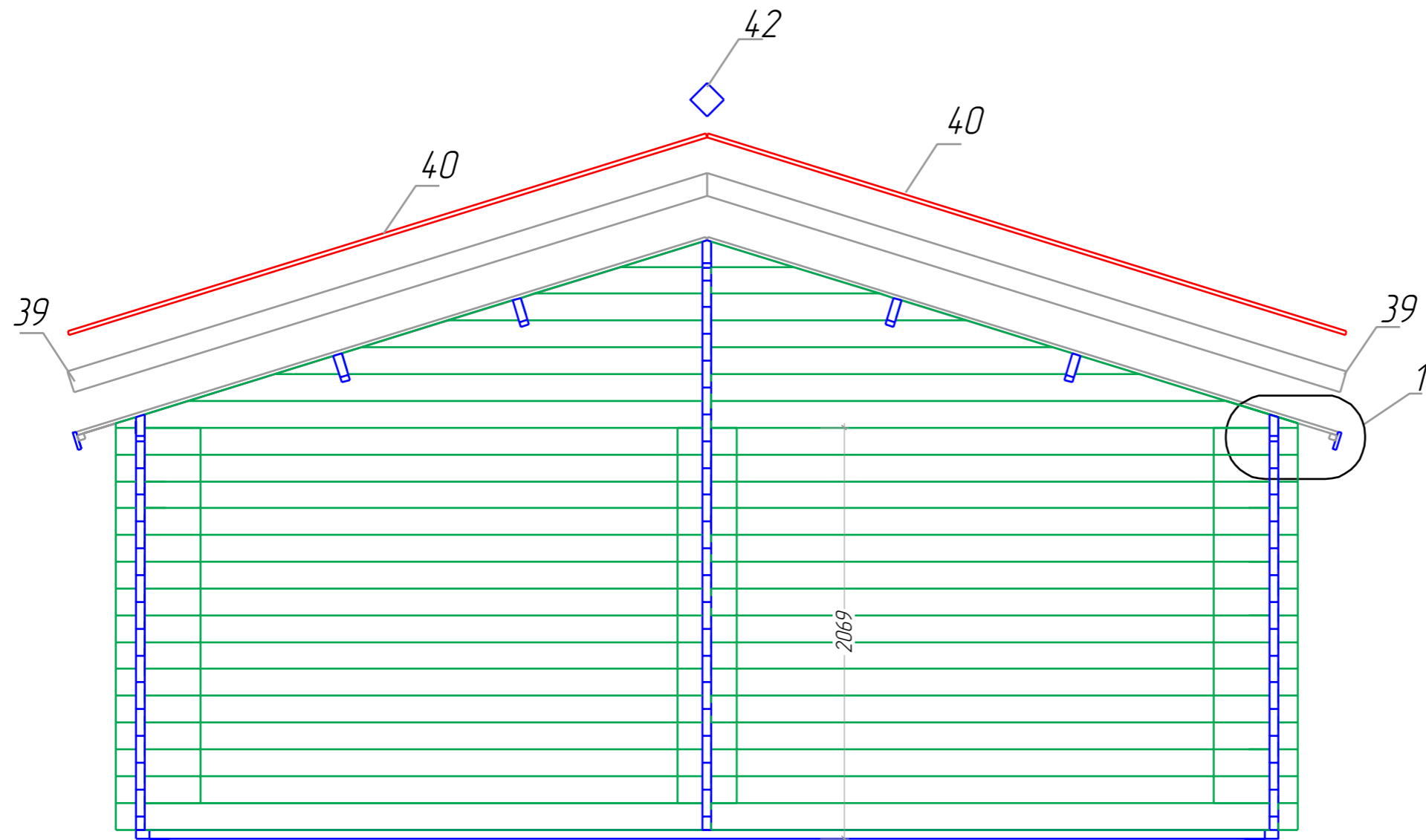

Garage double 6x6 (44)
M 1:40

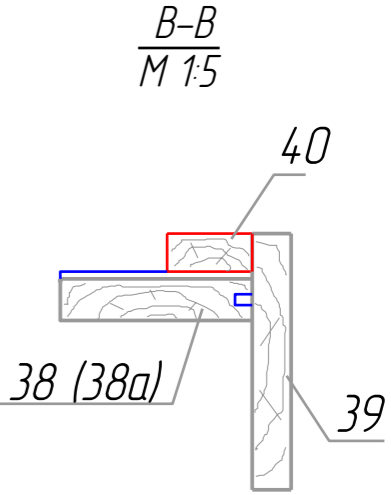
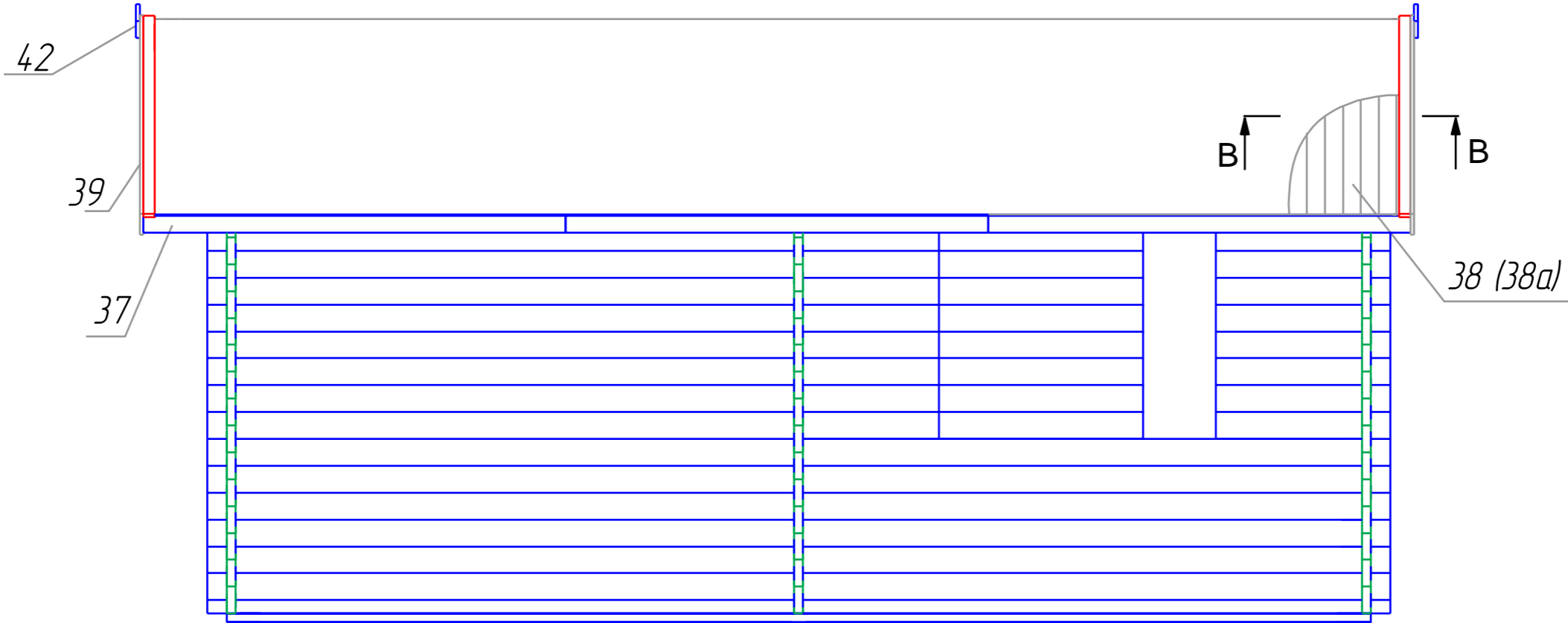

Garage double 6x6 (44)

Boarding joist plan
Trummplan
Plan des lambourdes

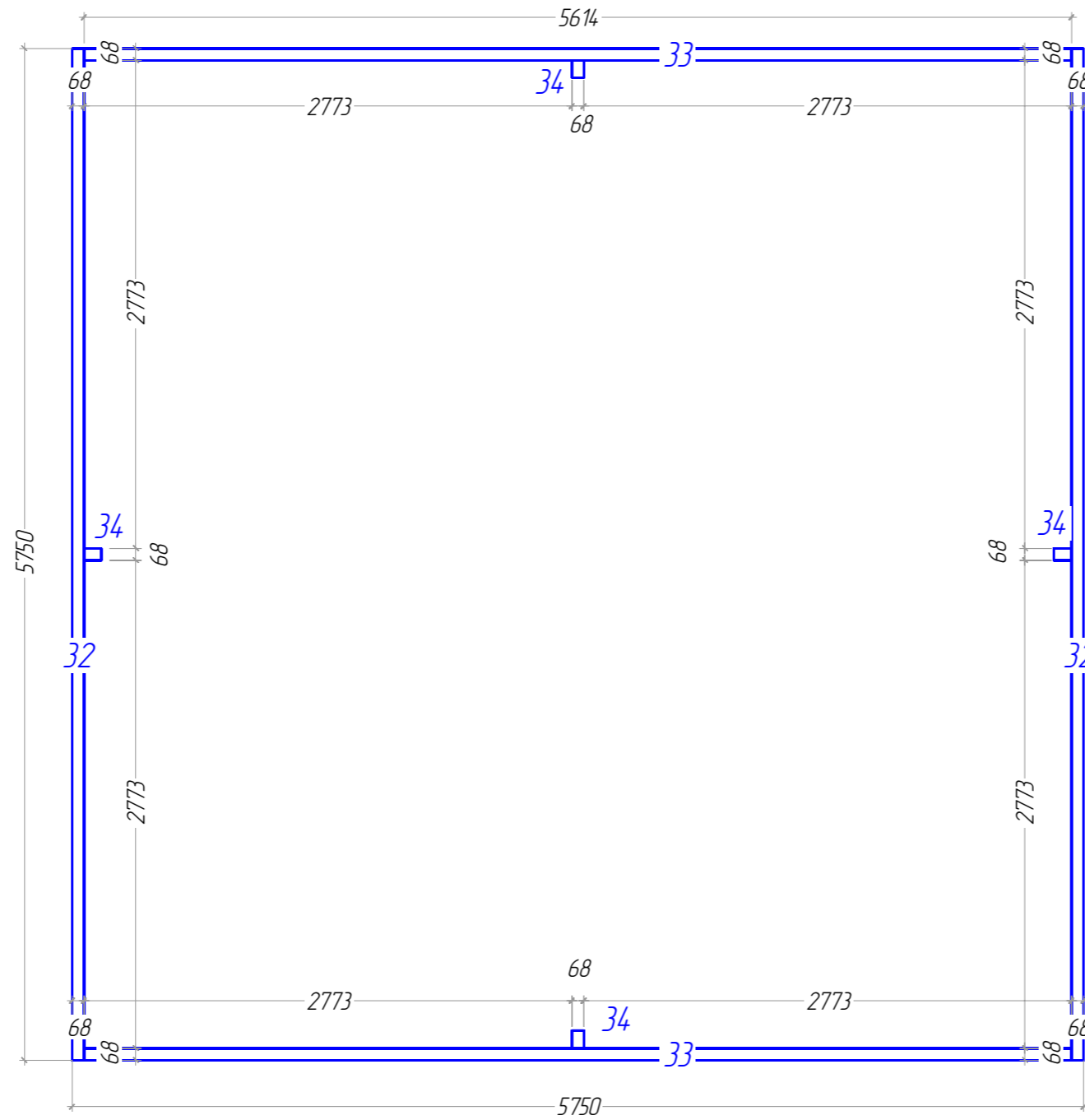

M 1:50





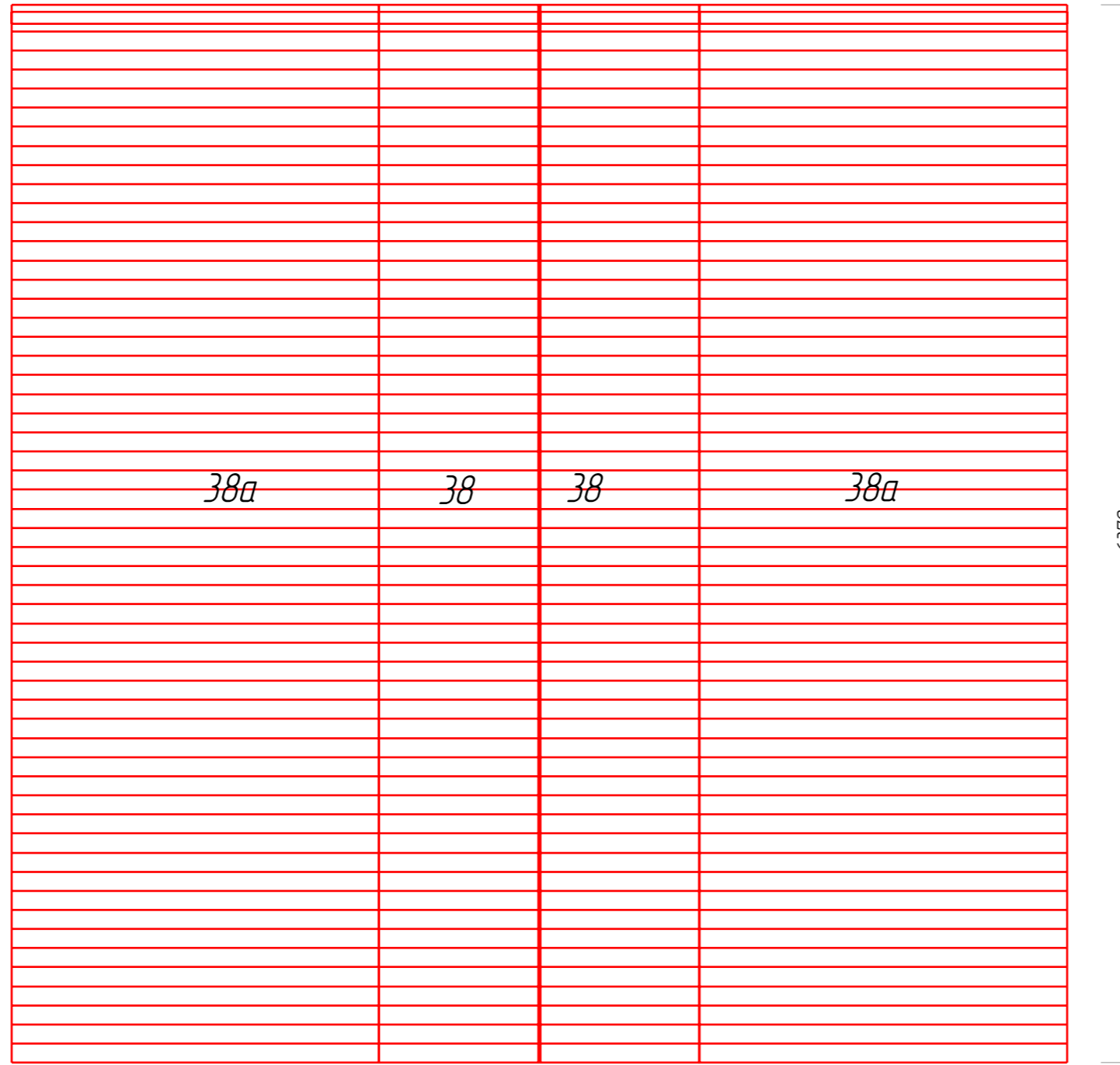

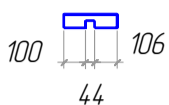
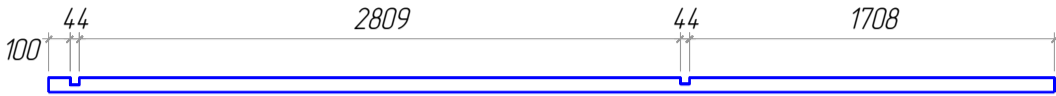

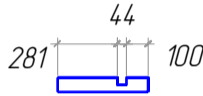
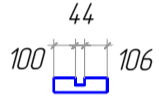
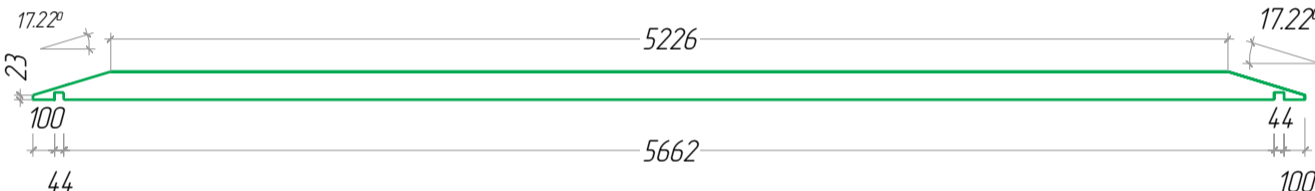
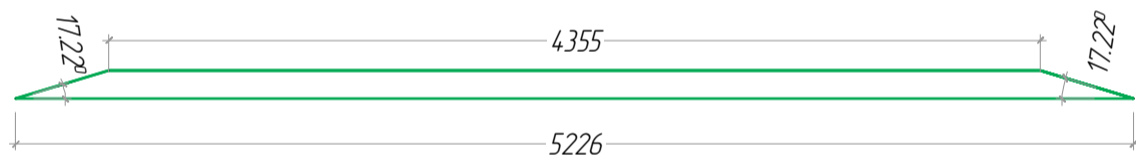
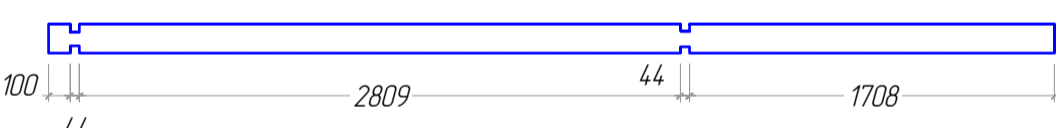
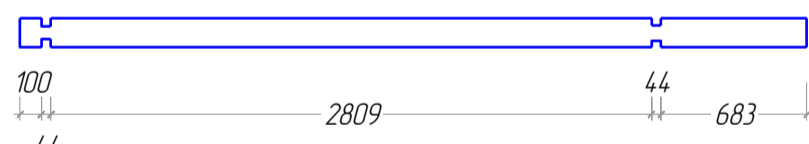
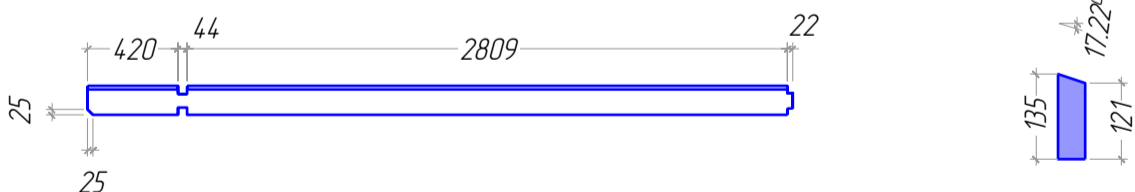
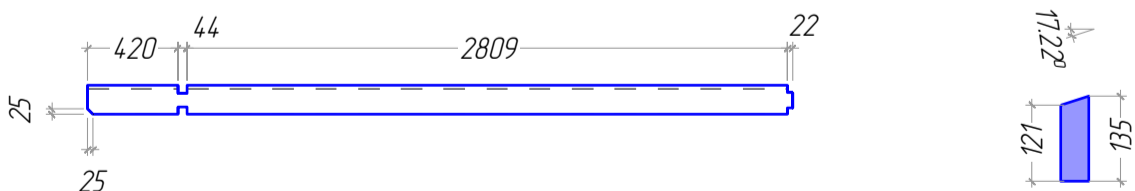
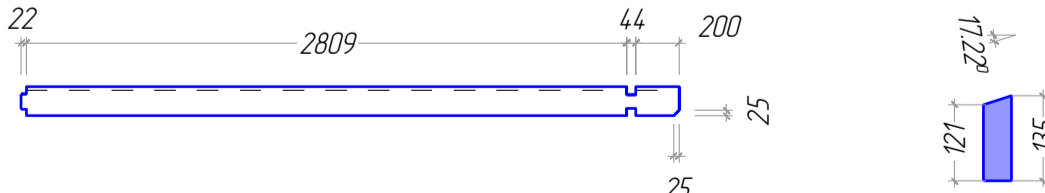
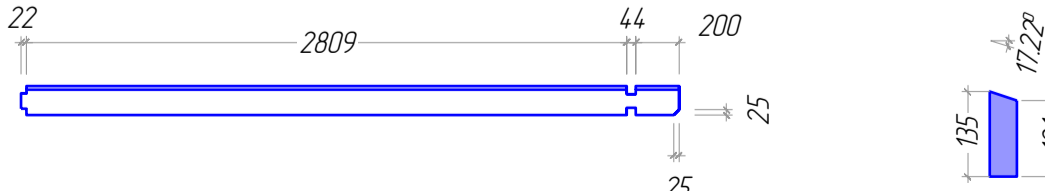

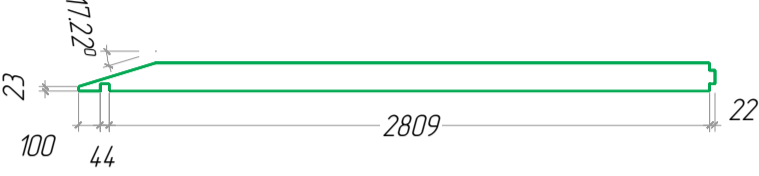
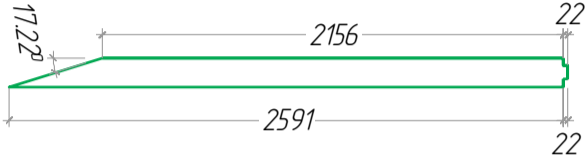

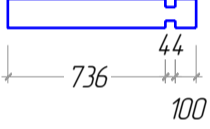
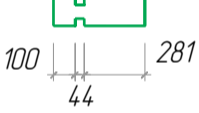
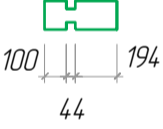
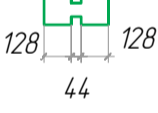
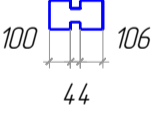

Garage double 6x6 (44)

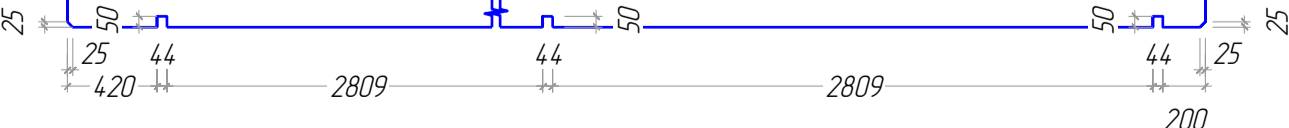
Plan of the roof board
Plan der Dachbretter
Le plan des planches du toit

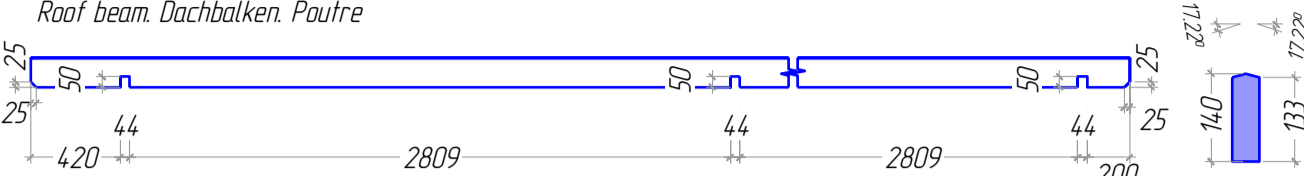

| Nº | Garage double 6x6 (44) | Nr. | Profile (mm) | Lenght (mm) |
|----|--|-----|--------------|-------------|
| 1 |  | 2 | 44x62,5 | 250mm |
| 2 |  | 1 | 44x67,5 | 4705mm |
| 3 |  | 2 | 44x67,5 | 2975mm |
| 4 |  | 1 | 44x67,5 | 425mm |
| 5 |  | 2 | 44x67,5 | 250mm |
| 7 |  | 1 | 44x135 | 5950mm |
| 8 |  | 1 | 44x135 | 5226mm |
| 9 |  | 6 | 44x135 | 4705mm |
| 12 |  | 8 | 44x135 | 3680mm |
| 15 |  | 1 | 44x135 | 3295mm |
| 16 |  | 1 | 44x135 | 3295mm |
| 17 |  | 1 | 44x135 | 3075mm |
| 18 |  | 1 | 44x135 | 3075mm |

| Nº | Garage double 6x6 (44) | Nr. | Profile (mm) | Lenght (mm) |
|----|--|------|--------------|-------------|
| 19 |  | 44+2 | 44x135 | 2975mm |
| 20 |  | 4 | 44x135 | 2975mm |
| 22 |  | 4 | 44x135 | 2613mm |
| 24 |  | 8 | 44x135 | 2435mm |
| 27 |  | 16 | 44x135 | 880mm |
| 28 |  | 44 | 44x135 | 425mm |
| 29 |  | 2 | 44x135 | 338mm |
| 30 |  | 14 | 44x135 | 300mm |
| 31 |  | 66 | 44x135 | 250mm |
| 32 | Foundation Fundament Solve  | 2 | 44x68 | 5750mm |
| 33 | Foundation Fundament Solve  | 2 | 44x68 | 5614mm |
| 34 | Foundation Fundament Solve  | 4 | 44x68 | 100mm |
| 35 | Roof beam. Dachbalken. Poutre  | 4 | 44x140 | 6370mm |

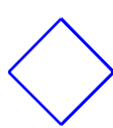
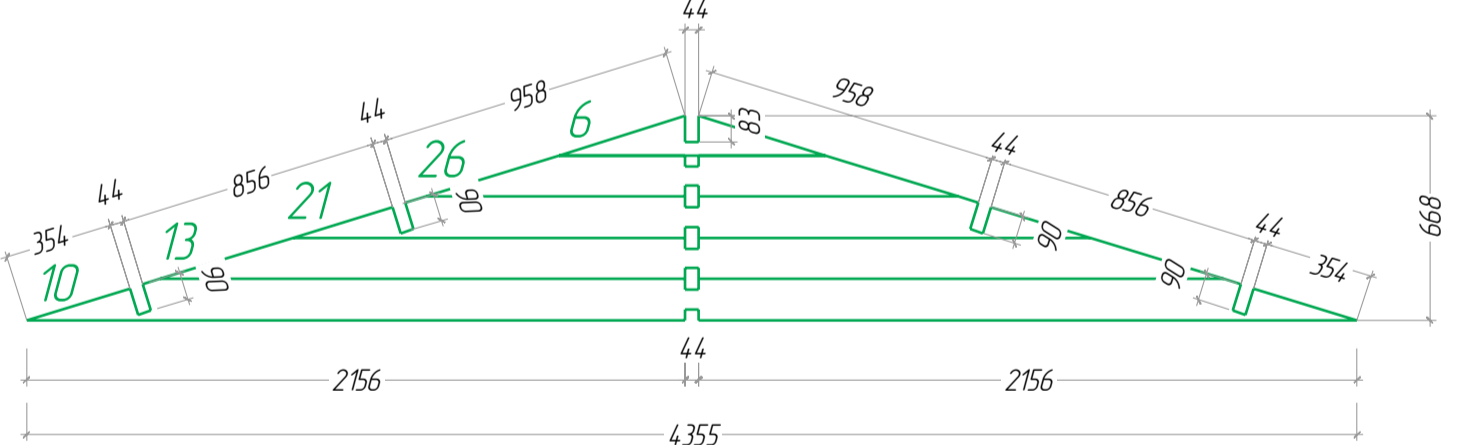
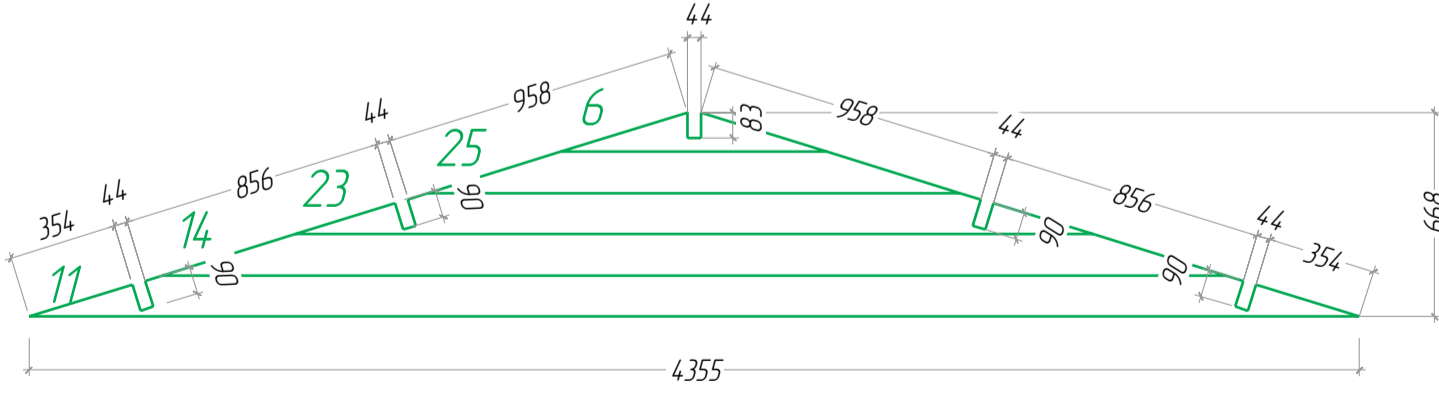
| N° | Garage double 6x6 (44) | Nr. | Profile (mm) | Length (mm) |
|-----------|---|----------------|--------------|------------------|
| 36 | <p>Roof beam. Dachbalken. Poutre</p>  | 1 | 44x140 | 6370mm |
| 37 | <p>Roof side boards Traufenbrett Planche de rive</p>  | 6 | 17x90 | 2123mm |
| 38 38a | <p>Roof boards. Dachbretter Volige</p>  | 112+1 112+1 | 20x115 | 1003mm 2317mm |
| 39 | <p>Fascia board Giebelblende Planche de rive facade</p>  | 4 | 20x120 | 3370mm |
| 40 | <p>Roofing felt fillet Giebelabschlussbrett Latte de finition couverture</p>  | 4 | 20x58 | 3363mm |
| 41 | <p>Roof edge reinforcement Traufenleiste Tasseau</p>  | 6 | 28x34 | 2123mm |
| 42 | <p>Diamond Raute Diamant</p>  | 2 | 20x120 | 120mm |
| W-1 |  | 2 | | |
| W-2 |  | 1 | | |
| | <p>Door Tur La porte</p> <p>1958x820 mm</p> | 1 | | |
| | <p>Window Fenetre Fenster</p> <p>1080x1390 mm</p> | 2 | | |

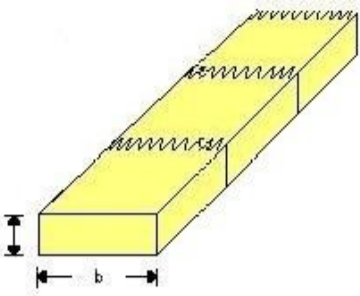
| N° | <i>Garage double 6x6 (44)</i> | Nr. | Profile (mm) | Lenght (mm) |
|----|--|-----|-----------------|----------------|
| |  <p data-bbox="344 676 1520 783"><i>Les planches n.35, n.36, n.7, n.8, n.32, n.33 sont jointes par entures multiples afin de garantir la stabilite de la construction</i></p> | | | |